

CAMWorks Multi Axis Machining

For Machining Complex Shapes

- **CAMWorks Multi Axis Machining** gives shops and manufacturing facilities the ability to take full advantage of 4/5-axis machines that provide greater productivity, equipment flexibility, and higher quality. CAMWorks Multi-axis Machining creates toolpaths across complex shapes that would require multiple setups on 3-axis machines to be machined in a single setup, including automotive port finishing, impellers, turbine blades, cutting tools, parts requiring trimming/deflashing, undercut machining and much more.

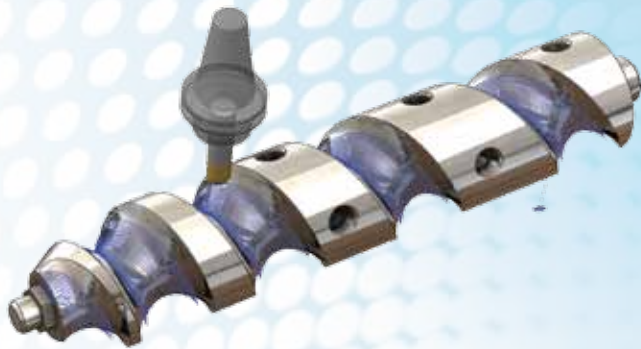

- **Knowledge-based machining** allows you to capture and reuse your programmers' and machinists' best practices using the Technology Database, reducing programming time by as much as 80% and provides a company owned database to store employee knowledge and skill.
- **Full Model to toolpath associativity** automatically

updates the toolpaths and CAM data to design changes made to the model.

- **Seamless integration** inside of SolidWorks means that the design model and CAM model are one in the same and a similar interface with the same intuitive menus, toolbars and view manipulation, allows users to quickly master the software.
- **Reduce Cycle Time** Shorter cutting tools can be used since the tool can be tilted to adjust the angle between the cutter and the part. The increased rigidity of shorter tools allows you to take advantage of the high-speed options to machine at higher speeds with no loss in accuracy.
- **Improve Surface Finish** Generating 5-axis swarf toolpaths instead of traditional 3-axis toolpaths can result in fewer cut passes and improved surface finish.
- **Extend Tool Life** By optimizing the angle between the tool and the surface; it is possible to achieve a constant chip load and a high feedrate at the contact point. The result is improved surface finish and extended tool life.

- **Higher Quality** Parts that previously required multiple setups can be machined in a single setup with simultaneous control of the rotary axis. In addition to saving time, a single setup improves the quality and accuracy of the parts, and eliminates mistakes might result during multiple setups.
- **Advanced Roughing** options include multiple cuts normal to the surface, multiple cut depths along the tool axis and full 5-axis plunge roughing.
- **Collision detection** looks at each toolpath and the surfaces to decide if the tool tip, tool shaft or holder is colliding. The check is done at each

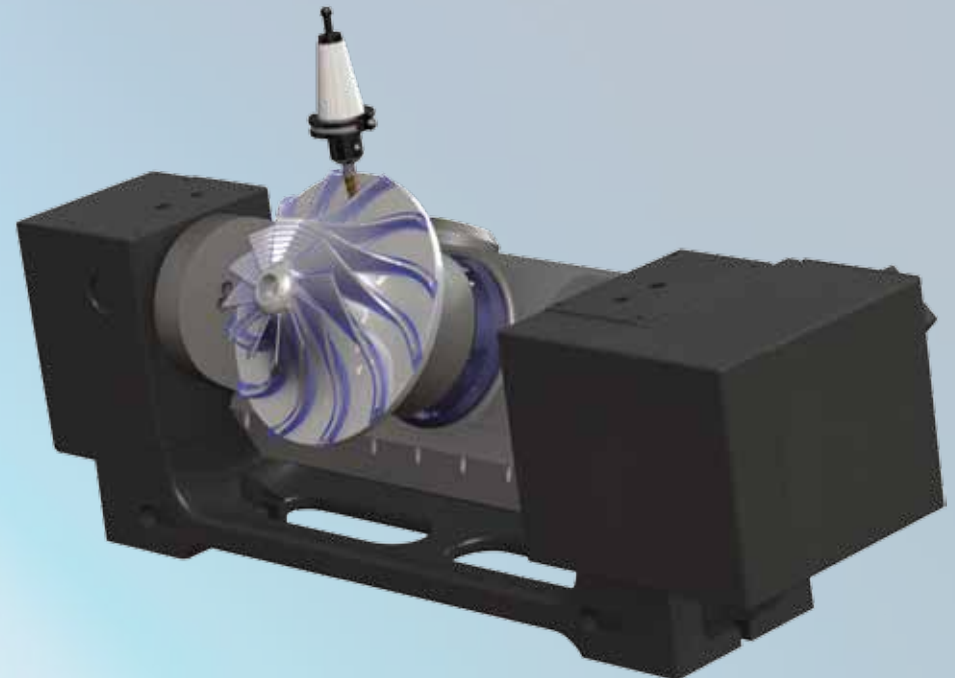

CAMWorks Multi Axis Machining

calculated tool position. Groups of surfaces can be defined, each with its own avoidance strategy.

- **3 Axis Undercut Machining** for complex parts using lollipop and keyway cutters.
- **Impeller Blade Machining** options provide more control for machining impeller blades.
- **Rest machining** Options take advantage of existing stock geometry to minimize air cuts during roughing operations.
- Numerous options provide simple and easy trimming of vacuum-formed or fiber reinforced plastic parts.

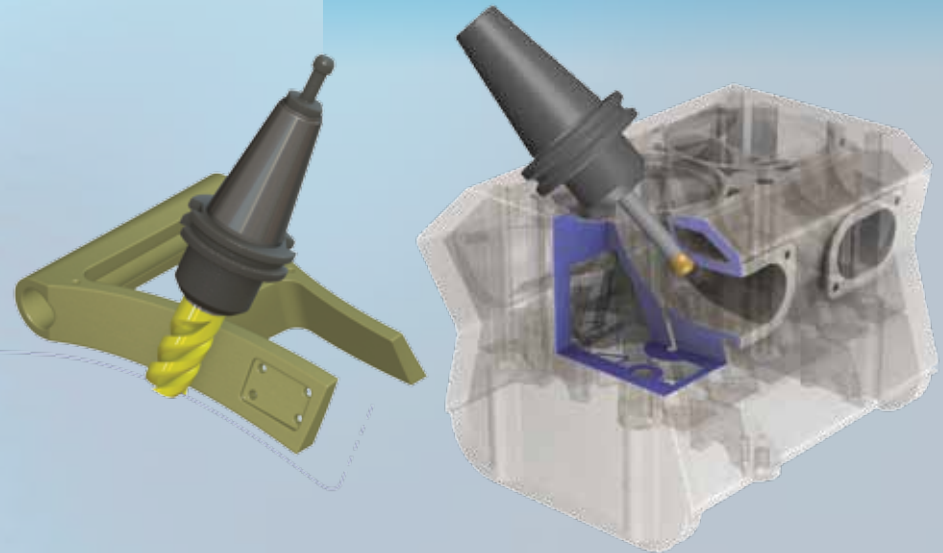
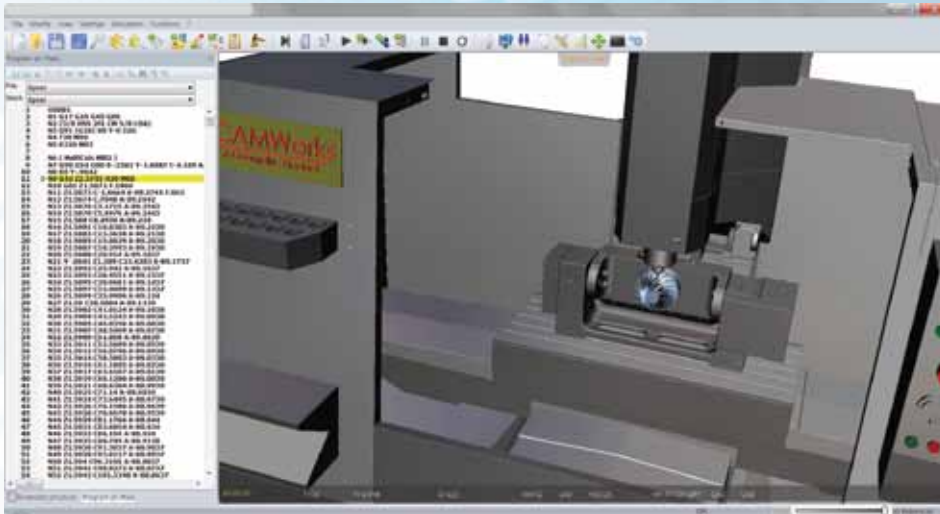

- **Machine Simulation*** provides a realistic simulation of the complete machine tool, enabling collision checking between the tool and the machine components.
- **True G-Code Verification*** validates the actual code before running it on the machine. This simulation shows the toolpath based on the G code generated in CAMWorks and the CAD model.

**These are optional products. See your CAMWorks reseller today for more information.*

About Geometric

Geometric is a specialist in the domain of engineering solutions, services and technologies. Its Geometry Technology Solutions (GTS) business unit develops cutting-edge point productivity solutions that enhance design and improve manufacturing operations. The end-user products from Geometric include CAMWorks[®], eDrawings[®] Publisher, DFMPPro, GeomCaliper[®], 3DPaintBrush[™], CAMWorksXpress[®] and Glovius[®]. The key technologies from Geometric are NestLib[®], Feature Recognition (FR), GeomDiff and 3DSearchIT[®]. Geometric licenses these technologies to OEM partners and also designs and implements customized process solutions using these technologies for industrial customers.

For further details about Geometric's GTS business unit, please visit www.geometricglobal.com/products or call +1.480.222.2255

The copyrights/trademarks of all products referenced herein, are held by their respective companies.

CAMWorks

To know more about this solution:

email: inquiries@camworks.com

Website: www.camworks.com